

COOK PORTABLE WAREHOUSES

100 DOUGLAS STREET
VALDOSTA, GA 31601

MASTER ANCHORING PLANS FOR THE INTERNATIONAL BUILDING CODE 2012

GENERAL NOTES

1. THE CONTRACTOR SHALL BE RESPONSIBLE FOR VERIFYING ALL EXISTING CONDITIONS.
2. THE CONTRACTOR SHALL BE RESPONSIBLE FOR COORDINATING ARCHITECTURAL, STRUCTURAL, MECHANICAL, AND ELECTRICAL DETAIL AND DIMENSIONS. ANY DISCREPANCIES BETWEEN SUCH DETAILS AND DIMENSIONS SHALL BE REPORTED TO THE ENGINEER PRIOR TO PROCEEDING WITH THE WORK.
3. THE CONTRACTOR SHALL BE RESPONSIBLE FOR ERECTION PROCEDURE AND SEQUENCE TO INSURE THE INTEGRITY OF THE BUILDING AND ITS COMPONENT PARTS DURING CONSTRUCTION.
4. THESE PLANS HAVE BEEN PREPARED PER REGULATIONS OF THE 2012 INTERNATIONAL BUILDING CODE. THE WORK OF ALL CONTRACTORS SHALL COMPLY WITH THE REQUIREMENTS SET FORTH IN THE AFOREMENTIONED CODE. NO DEVIATIONS FROM THE WORK SHOWN OR REASONABLY IMPLIED SHALL BE UNDERTAKEN WITHOUT THE ENGINEER'S WRITTEN CONSENT - A COPY OF WHICH WILL BE FILED WITH THE CONSTRUCTION OFFICIAL.
5. ANY CHANGES TO OR DEVIATIONS FROM THESE DRAWINGS SHALL NOT BE MADE WITHOUT WRITTEN CONSENT FROM THE ENGINEER.
6. THESE DRAWINGS ARE THE PROPERTY OF THE ENGINEER AND SHALL NOT BE USED WITHOUT HIS CONSENT. DRAWINGS SHALL NOT BE USED FOR ISSUE OF BUILDING PERMIT UNLESS SIGNED AND SEALED BY THE ENGINEER.
7. THE OWNER AND THE CONTRACTOR SHALL HOLD HARMLESS THE ENGINEER FROM AND AGAINST ALL LIABILITY CLAIMS, DAMAGES, LOSSES AND EXPENSES INCLUDING LEGAL FEES ARISING OUT OF OR RESULTING FROM ERRORS OR OMISSIONS IN THE PERFORMANCE OF THE WORK BY THE CONTRACTOR. THE DRAWINGS SHOW THE GENERAL ARRANGEMENTS AND EXTENT OF THE WORK. AS THE WORK PROGRESSES, THE OWNER AND THE CONTRACTOR, AT NO EXTRA COSTS, SHALL MAKE MODIFICATIONS TO MAKE THE PARTS ALIGN.
8. ALL WORK AND MATERIALS SHALL MEET THE REQUIREMENTS OF LOCAL AND STATE CODES AND THE SPECS OF THE NATIONAL BOARD OF FIRE UNDERWRITERS. CONTRACTORS SHALL CHECK AND VERIFY ALL PLAN DIMENSIONS AND CONDITIONS BEFORE PROCEEDING CONSTRUCTION. HE SHALL REPORT ANY DISCREPANCIES TO THE ENGINEER FOR CORRECTION PRIOR TO BEGINNING ANY WORK. THE DISCOVERY OF DISCREPANCIES AFTER THE BEGINNING OF WORK WILL BE EVIDENCE OF FAULTY WORK AND SHALL BE THE RESPONSIBILITY OF THE CONTRACTOR. DO NOT SCALE DRAWINGS. ALL WRITTEN DIMENSIONS GOVERN.
9. THE CONTRACTOR FOR THIS PROJECT SHALL INCLUDE ALL MATERIALS AND LABOR REQUIRED TO COMPLETE THE TOTAL PROJECT. THE CONTRACTOR SHALL FURNISH AND PAY FOR ALL MATERIALS, TOOLS, EQUIPMENT, LABOR, MACHINERY, TRANSPORTATION, HEAT, WATER, UTILITIES, AND ALL OTHER FACILITIES AND SERVICES REQUIRED FOR THE SAFE AND PROPER EXECUTION AND COMPLETION OF THE WORK. THE ENGINEER SHALL BE THE INTERPRETER OF THE CONTRACT DOCUMENTS.
10. THE DOCUMENTS SHOW AN OVERVIEW OF THE WORK REQUIRED UNDER THIS CONTRACT AND RELATED REQUIREMENTS AND CONDITIONS THAT WILL IMPACT THE PROJECT. ALL DRAWINGS ARE COMPLIMENTARY. THE DRAWINGS GENERALLY SHOW THE INTENT OF THE OVERALL COMPLEXITY AND CONCEPTS OF THE PROJECT, AND DO NOT NECESSARILY SHOW ALL DETAILS AND CONDITIONS. ALL NEW INTERIOR CONCRETE SLABS AND FOUNDATION WALLS AND FOOTINGS SHALL HAVE SOIL POISONING UNDER NEW WORK AND SHALL BE INSTALLED BY A LICENSED CONTRACTOR.
11. ALL WORK SHALL BE COMPLETED IN ACCORDANCE WITH ALL STATE AND DEPARTMENT OF AGRICULTURE, STRUCTURAL PEST CONTROL DIVISION REGULATIONS, RULES, DEFINITIONS AND REQUIREMENTS.
12. THE CONTRACTOR SHALL BE RESPONSIBLE FOR VERIFYING AND MAINTAINING ALL EXISTING SETBACKS, EASEMENTS, AND ANY DEED RESTRICTIONS.
13. THE GENERAL CONTRACTOR SHALL BE RESPONSIBLE FOR FINAL CLEANUP AND SHALL INCLUDE THE SITE, AND THE BUILDING. THE ENTIRE PROJECT SHALL BE LEFT IN A NEW, CLEAN CONDITION.

SHEET INDEX

SHEET NUMBER	SHEET TITLE
C-1	COVER SHEET
A-1	EXP. "B" WIND CHARTS
A-2	EXP. "C" WIND CHARTS
A-3	WIND MAP & LOADING DIAGRAM
A-4	EXP. "B" ANCHOR CHARTS
A-5	EXP. "C" ANCHOR CHARTS
A-6	GROUND ANCHOR SCHEDULE
A-7	ANCHORING DETAILS
A-8	ANCHORING DETAILS
A-9	OPTIONAL PAD DETAILS

THOMAS A. DIXON, P.E.

AL# 30637	TX# 104353	DIXON ENGINEERING, INC.
SC# 27542	VA# 045543	STRUCTURAL ENGINEERING AND
WV# 071436	FL# 34222	INSPECTION - COA 8145
PA# 079004	KS# 21148	10410 MAIN STREET
TN# 112761	GA# 034371	THONOTOSASSA, FL 33542
MS# 14034	MD# 40405	VOICE: 813-482-4885
NC# 035485		FAX: 813-482-2306

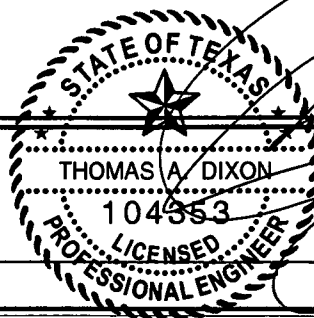

COOK PORTABLE WAREHOUSES
MASTER ANCHORING PLAN
100 DOUGLAS STREET
VALDOSTA, GA 31601
PHONE: 1-229-241-8805

COVER SHEET

REV	BY	DATE

DATE: 3/13/12
DRN BY: JDA
CHK BY: TAD
SCALE: AS NOTED
P.L.O. NO: 445-063

SHEET

C-1

1 of 10

MWFRS 160 MPH EXP. "B"

ZONE	TABLE PRESSURE ¹	ADJUSTMENT FACTOR ²	LOAD COMBINATION FACTOR ³	WORKING PRESSURE (PSF)
A	54.12	1.0	0.6	32.5
B	-15.64	1.0	0.6	-9.4
E	-48.8	1.0	0.6	-29.3
F	-33.16	1.0	0.6	-19.9

MWFRS 130 MPH EXP. "B"

ZONE	TABLE PRESSURE ¹	ADJUSTMENT FACTOR ²	LOAD COMBINATION FACTOR ³	WORKING PRESSURE (PSF)
A	35.74	1.0	0.6	21.5
B	-10.36	1.0	0.6	-6.3
E	-32.2	1.0	0.6	-19.4
F	-21.84	1.0	0.6	-13.1

MWFRS 110 MPH EXP. "B"

ZONE	TABLE PRESSURE ¹	ADJUSTMENT FACTOR ²	LOAD COMBINATION FACTOR ³	WORKING PRESSURE (PSF)
A	25.6	1.0	0.6	15.4
B	-7.4	1.0	0.6	-4.5
E	-23.1	1.0	0.6	-13.9
F	-15.64	1.0	0.6	-9.4

NOTES:

SEE FIGURE 28.6-1 PAGE 303-305 IN ASCET-10.

SEE FIGURE 28.6-1 PAGE 305 IN ASCET-10.

SEE SECTION 2.4.1 IN ASCET-10.

DESIGN PRESSURES SHOWN ARE BASED ON WORST-CASE DESIGN CONDITIONS OF BUILDINGS FOR WIND VELOCITIES PER 2012 I.B.C.

THOMAS A. DIXON, P.E.

AL# 30637	TX# 104353	DIXON ENGINEERING, INC.
SC# 27592	VA# 045593	STRUCTURAL ENGINEERING AND
WV# 071936	FL# 34222	INSPECTION - COA 8195
PA# 0719004	K5# 21198	10410 MAIN STREET
TN# 112761	GA# 034371	THONOTOSASSA, FL 33592
MS# 19034	MD# 40905	VOICE: 813-482-4885
NC# 035485		FAX: 813-482-2306

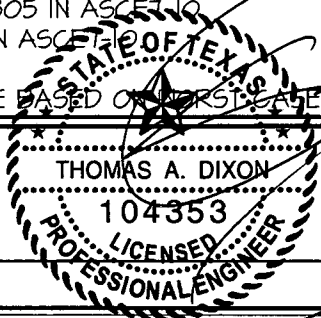

COOK PORTABLE WAREHOUSES
 MASTER ANCHORING PLAN
 100 DOUGLAS STREET
 VALDOSTA, GA 31601
 PHONE: 1-229-241-8805

EXP. "B" WIND CHARTS

REV	BY	DATE

DATE: 3/13/12
 DRN BY: JDA
 CHK BY: TAD
 SCALE: AS NOTED
 PLO. NO: 445-063

SHEET

A-1

2 of 10

MWFRS 160 MPH EXP. "C"

ZONE	TABLE PRESSURE ¹	ADJUSTMENT FACTOR ²	LOAD COMBINATION FACTOR ³	WORKING PRESSURE (PSF)
A	54.12	1.21	0.6	39.4
B	-15.64	1.21	0.6	-11.4
E	-48.8	1.21	0.6	-35.5
F	-33.16	1.21	0.6	-24.1

MWFRS 130 MPH EXP. "C"

ZONE	TABLE PRESSURE ¹	ADJUSTMENT FACTOR ²	LOAD COMBINATION FACTOR ³	WORKING PRESSURE (PSF)
A	35.74	1.21	0.6	26.1
B	-10.36	1.21	0.6	-7.7
E	-32.2	1.21	0.6	-23.5
F	-21.84	1.21	0.6	-15.9

MWFRS 110 MPH EXP. "C"

ZONE	TABLE PRESSURE ¹	ADJUSTMENT FACTOR ²	LOAD COMBINATION FACTOR ³	WORKING PRESSURE (PSF)
A	25.6	1.21	0.6	18.7
B	-7.4	1.21	0.6	-5.5
E	-23.1	1.21	0.6	-16.9
F	-15.64	1.21	0.6	-11.4

NOTES:

SEE FIGURE 28.6-1 PAGE 303-305 IN ASC7-10.
 SEE FIGURE 28.6-1 PAGE 305 IN ASC7-10.
 SEE SECTION 2.4.1 IN ASC7-10.
 DESIGN PRESSURES SHOWN ARE BASED ON MOST CASE DESIGN CONDITIONS OF BUILDINGS FOR WIND VELOCITIES PER 2012 I.B.C.

THOMAS A. DIXON, P.E.

AL# 30637	TX# 104353	DIXON ENGINEERING, INC.
SC# 27542	VA# 045543	STRUCTURAL ENGINEERING AND
WV# 071436	FL# 34222	INSPECTION - COA 8145
PA# 079009	KS# 21148	10410 MAIN STREET
TN# 112761	GA# 034371	THONOTOSASSA, FL 33542
MS# 19034	MD# 40905	VOICE: 813-482-4885
NC# 035485		FAX: 813-482-2306

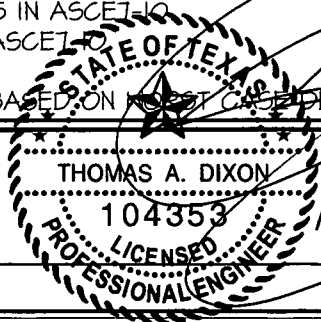

COOK PORTABLE WAREHOUSES
 MASTER ANCHORING PLAN
 100 DOUGLAS STREET
 VALDOSTA, GA 31601
 PHONE: 1-229-241-8805

EXP. "C" WIND CHARTS

REV	BY	DATE

DATE:	3/13/12
DRN BY:	JDA
CHK BY:	TAD
SCALE:	AS NOTED
W.O. NO.:	445-063

SHEET
A-2
 3 of 10

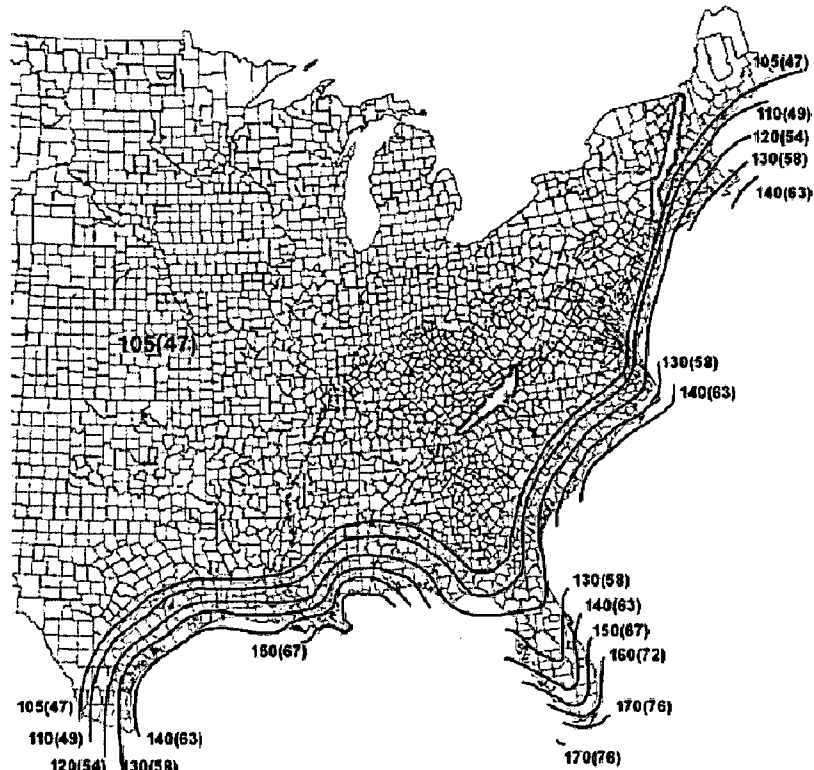

Location	Vmph	(m/s)
Guam	180	(80)
Virgin Islands	150	(67)
American Samoa	150	(67)
Hawaii - <u>Special Wind Region States</u>	115	(51)

Figure 26.5-1c (Continued)

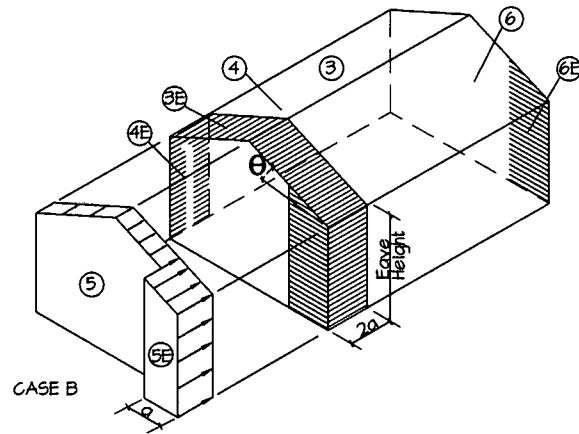
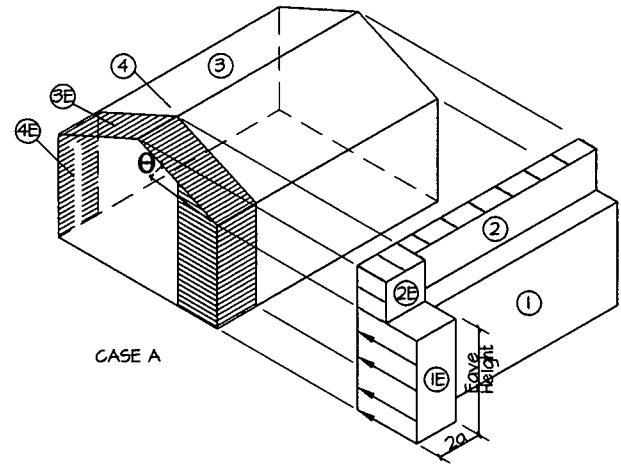

WIND LOAD MAIN WIND FORCE PRESSURE DIAGRAMS

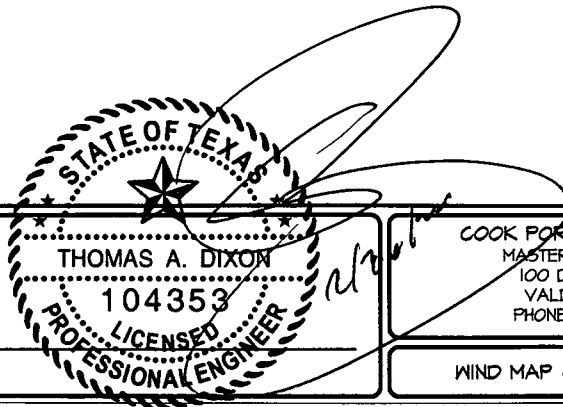

THOMAS A. DIXON, P.E.

AL# 30637	TX# 104353	DIXON ENGINEERING, INC.
SC# 21542	VA# 045543	STRUCTURAL ENGINEERING AND
WV# 071436	FL# 34222	INSPECTION - COA 8145
PA# 079009	KS# 21148	10410 MAIN STREET
TN# 112761	GA# 034371	THONOTOSASSA, FL 33542
MS# 19034	MD# 40905	VOICE: 813-482-4885
NC# 035485		FAX: 813-482-2306

COOK PORTABLE WAREHOUSES
 MASTER ANCHORING PLAN
 100 DOUGLAS STREET
 VALDOSTA, GA 31601
 PHONE: 1-229-241-8805

REV	BY	DATE

DATE:	3/13/12
DRN BY:	JDA
CHK BY:	TAD
SCALE:	AS NOTED
W.O. NO.:	445-063

WIND MAP & LOADING DIAGRAM

SHEET

A-3

4 of 10

SCHEDULES FOR ANCHORS PLACED VERTICAL INTO GROUND

ANCHORING SCHEDULE FOR UP TO 110 MPH WIND SPEED, EXPOSURE "B"

BLDG WIDTH	NUMBER OF ANCHORS EACH SIDE												
	8'-0"	10'-0"	12'-0"	14'-0"	16'-0"	18'-0"	20'-0"	22'-0"	24'-0"	26'-0"	28'-0"	30'-0"	32'-0"
7'-11 1/2"	2	2	2	3	3	3	3	3	3	N.A.	N.A.	N.A.	N.A.
9'-11 1/2"	2	2	2	2	2	2	3	3	3	3	3	3	N.A.
11'-0"	2	2	2	2	2	2	3	3	3	3	3	3	3

ANCHORING SCHEDULE FOR 111 TO 130 MPH WIND SPEED, EXPOSURE "B"

BLDG WIDTH	NUMBER OF ANCHORS EACH SIDE												
	8'-0"	10'-0"	12'-0"	14'-0"	16'-0"	18'-0"	20'-0"	22'-0"	24'-0"	26'-0"	28'-0"	30'-0"	32'-0"
7'-11 1/2"	2	2	2	3	3	3	3	4	4	N.A.	N.A.	N.A.	N.A.
9'-11 1/2"	2	2	2	2	2	3	3	3	3	3	3	4	N.A.
11'-0"	2	2	2	2	2	2	3	3	3	3	3	3	4

ANCHORING SCHEDULE FOR 131 TO 160 MPH WIND SPEED, EXPOSURE "B"

BLDG WIDTH	NUMBER OF ANCHORS EACH SIDE												
	8'-0"	10'-0"	12'-0"	14'-0"	16'-0"	18'-0"	20'-0"	22'-0"	24'-0"	26'-0"	28'-0"	30'-0"	32'-0"
7'-11 1/2"	3	3	4	4	4	5	5	6	6	N.A.	N.A.	N.A.	N.A.
9'-11 1/2"	3	3	3	3	4	4	4	5	5	5	5	6	N.A.
11'-0"	3	3	3	3	4	4	4	4	5	5	5	6	6

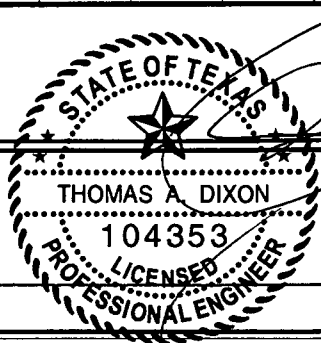

THOMAS A. DIXON, P.E.
 AL# 30637 TX# 104353 DIXON ENGINEERING, INC.
 SC# 21542 VA# 045543 STRUCTURAL ENGINEERING AND
 WV# 071436 FL# 34222 INSPECTION - COA 8145
 PA# 079009 KS# 21148 10410 MAIN STREET
 TN# 112761 GA# 034371 THONOTOSASSA, FL 33542
 MS# 14034 MD# 40405 VOICE: 813-482-4885
 NC# 035485 FAX: 813-482-2306

THOMAS A. DIXON
 104353
 LICENSED
 PROFESSIONAL ENGINEER

COOK PORTABLE WAREHOUSES
 MASTER ANCHORING PLAN
 100 DOUGLAS STREET
 VALDOSTA, GA 31601
 PHONE: 1-229-241-8805
 EXP. "B" ANCHOR CHARTS

REV	BY	DATE

DATE: 3/13/12
 DRN BY: JDA
 CHK BY: TAD
 SCALE: AS NOTED
 P.L.O. NO.: 445-063

SHEET
A-4
 5 of 10

SCHEDULES FOR ANCHORS PLACED VERTICAL INTO GROUND

ANCHORING SCHEDULE FOR UP TO 110 MPH WIND SPEED, EXPOSURE "C"

BLDG WIDTH	NUMBER OF ANCHORS EACH SIDE												
	8'-0"	10'-0"	12'-0"	14'-0"	16'-0"	18'-0"	20'-0"	22'-0"	24'-0"	26'-0"	28'-0"	30'-0"	32'-0"
7'-11 1/2"	2	2	3	3	3	3	3	4	4	N.A.	N.A.	N.A.	N.A.
9'-11 1/2"	2	2	2	2	3	3	3	3	3	3	3	4	N.A.
11'-0"	2	2	2	2	3	3	3	3	3	3	3	4	4

ANCHORING SCHEDULE FOR 111 TO 130 MPH WIND SPEED, EXPOSURE "C"

BLDG WIDTH	NUMBER OF ANCHORS EACH SIDE												
	8'-0"	10'-0"	12'-0"	14'-0"	16'-0"	18'-0"	20'-0"	22'-0"	24'-0"	26'-0"	28'-0"	30'-0"	32'-0"
7'-11 1/2"	3	3	3	4	4	4	4	5	5	N.A.	N.A.	N.A.	N.A.
9'-11 1/2"	2	3	3	3	3	3	4	4	4	4	4	5	N.A.
11'-0"	2	3	3	3	3	3	4	4	4	4	4	5	5

ANCHORING SCHEDULE FOR 131 TO 160 MPH WIND SPEED, EXPOSURE "C"

BLDG WIDTH	NUMBER OF ANCHORS EACH SIDE												
	8'-0"	10'-0"	12'-0"	14'-0"	16'-0"	18'-0"	20'-0"	22'-0"	24'-0"	26'-0"	28'-0"	30'-0"	32'-0"
7'-11 1/2"	3	3	4	4	5	5	6	6	6	N.A.	N.A.	N.A.	N.A.
9'-11 1/2"	2	3	3	3	4	4	4	5	5	5	6	6	N.A.
11'-0"	2	3	3	3	4	4	4	5	5	5	6	6	6

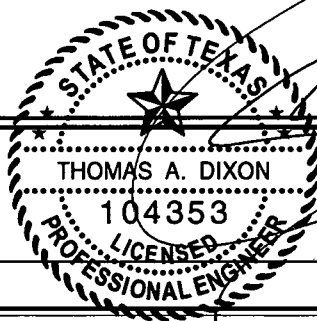

THOMAS A. DIXON, P.E.

AL# 30637	TX# 104353	DIXON ENGINEERING, INC.
SC# 27592	VA# 045593	STRUCTURAL ENGINEERING AND
WV# 071936	FL# 34222	INSPECTION - COA 8195
PA# 079009	KS# 21198	10410 MAIN STREET
TN# 112761	GA# 034371	THONOTOSASSA, FL 33592
MS# 19034	MD# 40905	VOICE: 813-482-4885
NC# 035485		FAX: 813-482-2306

COOK PORTABLE WAREHOUSES
 MASTER ANCHORING PLAN
 100 DOUGLAS STREET
 VALDOSTA, GA 31601
 PHONE: 1-229-241-8805

REV	BY	DATE

DATE:	3/13/12
DRN BY:	JDA
CHK BY:	TAD
SCALE:	AS NOTED
W.O. NO:	445-063

SHEET

A-5

6 of 10

EXP. "C" ANCHOR CHARTS

GROUND ANCHOR SCHEDULE

MODEL #	PART #	DESCRIPTION	SOIL CLASS
MI2H5/8	59080 / 59081	48" x 5/8" ROD WITH (1) 6" HELIX	4A
MI2H3/4	59085 / 59094	48" x 3/4" ROD WITH (1) 6" HELIX	4A
MI423/4	59128	42" x 3/4" ROD WITH (2) 4" HELIX	4A
MI483/4	59086	48" x 3/4" ROD WITH (2) 4" HELIX	4A
MI2H64	59250	36" x 3/4" ROD WITH (1) 4" HELIX, AND (1) 6" HELIX	4A
N/A	59065	EYE ANCHOR - 48" x 5/8" WITH (1) 6" HELIX	4A
N/A	59045	EYE ANCHOR - 48" x 3/4" WITH (1) 6" HELIX	4A
M607	59099	60" x 3/4" WITH (1) 7" HELIX	4B
N/A	59040	EYE ANCHOR - 60" x 3/4" WITH (1) 8" HELIX	4B

NOTE:

1. ALL APPROVED ANCHORS LISTED ABOVE ARE MANUFACTURED BY TIE DOWN ENGINEERING.
2. THE CONTRACTOR MAY USE AN APPROVED EQUIVALENT WITH APPROVAL FORM THE EOR.

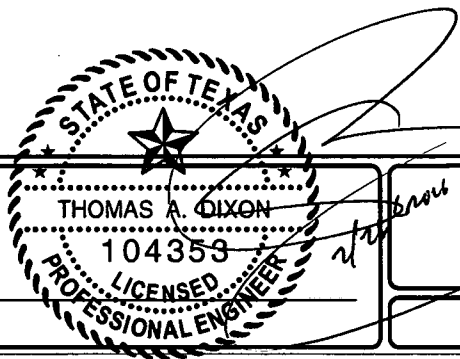

THOMAS A. DIXON, P.E.

AL# 30637	TX# 104353	DIXON ENGINEERING, INC.
SC# 27542	VA# 045543	STRUCTURAL ENGINEERING AND
MV# 071436	FL# 34222	INSPECTION - COA 8145
PA# 074009	KS# 21148	10410 MAIN STREET
TN# 112761	GA# 034371	THONOTOSASSA, FL 33542
MS# 14034	MD# 40405	VOICE: 813-482-4885
NC# 035485		FAX: 813-482-2306

THOMAS A. DIXON
 104353
 LICENSED
 PROFESSIONAL ENGINEER

COOK PORTABLE WAREHOUSES
 MASTER ANCHORING PLAN
 100 DOUGLAS STREET
 YALDOSTA, GA 31601
 PHONE: 1-229-241-8805

GROUND ANCHOR SCHEDULE

REV	BY	DATE

DATE:	3/13/12
DRN BY:	JDA
CHK BY:	TAD
SCALE:	AS NOTED
PLO. NO.:	445-063

SHEET

A-6

7 of 10

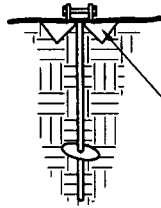

QUICK-SET STABILIZER PLATE #54291 BY TIE DOWN ENGINEERING OR EQUAL. AT ALL ANCHOR LOCATIONS EACH SIDE OF SHED. IF REQUIRED

TIE DOWN ENGINEERING DOUBLE TENSION PART NUMBER 59100.

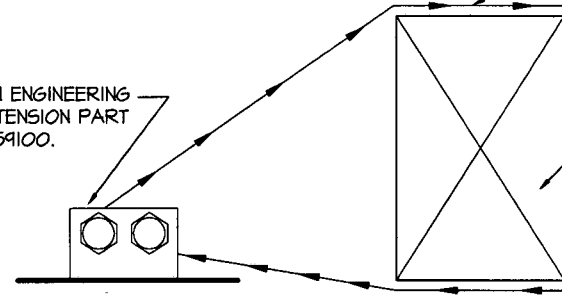

0.035" MIN. x 1-1/4" x 7'-0" GALVANIZED STEEL STRAPPING FED. SPEC. QQ-5TBI-H

BUILDING SKID REFER TO BUILDING PLANS FOR SIZE, LENGTH, AND LOCATION

1
A-7
**STABILIZER PLATE
OPTIONAL DETAIL**
SCALE: N.T.S.

2
A-7
**STRAP TO SKID
DETAIL**
SCALE: N.T.S.

NOTE:
SHIMS MAY BE PLACED UNDER SKIDS IN ORDER TO LEVEL THE BUILDING.

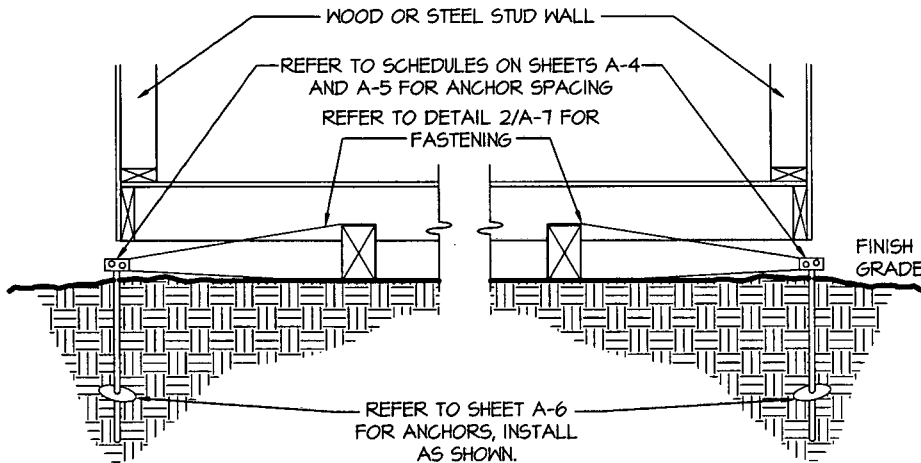

REFER TO SHEET A-6 FOR ANCHORS, INSTALL AS SHOWN.

ALL SKIDS ON GRADE
VERTICAL ANCHOR

3
A-7
SECTION
SCALE: N.T.S.

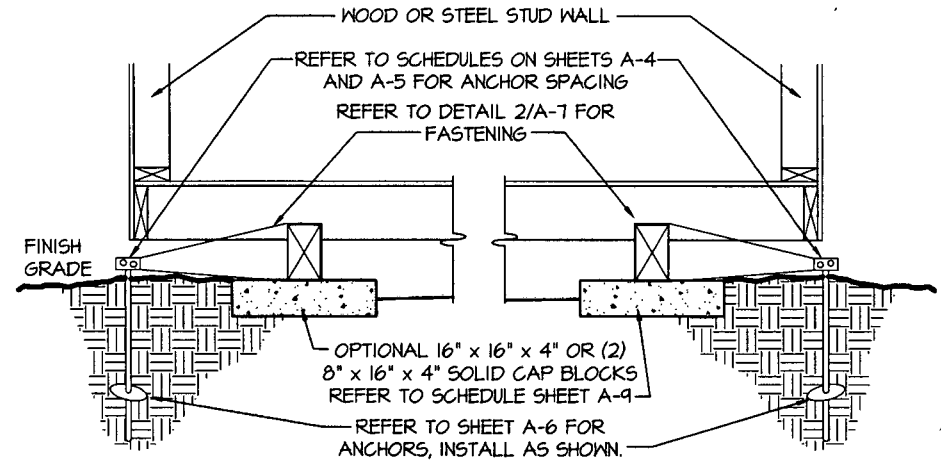

OPTIONAL 16" x 16" x 4" OR (2) 8" x 16" x 4" SOLID CAP BLOCKS REFER TO SCHEDULE SHEET A-9

REFER TO SHEET A-6 FOR ANCHORS, INSTALL AS SHOWN.

ALL SKIDS ON CONC. PADS
VERTICAL ANCHOR

4
A-7
SECTION
SCALE: N.T.S.

THOMAS A. DIXON, P.E.

AL# 30637	TX# 104353	DIXON ENGINEERING, INC.
SC# 27542	VA# 045543	STRUCTURAL ENGINEERING AND
HV# 071436	FL# 34222	INSPECTION - COA 8145
PA# 079009	KS# 21148	10410 MAIN STREET
TN# 112761	GA# 034371	THONOTOSASSA, FL 33542
MS# 19034	MD# 40905	VOICE: 813-482-4885
NC# 035485		FAX: 813-482-2306

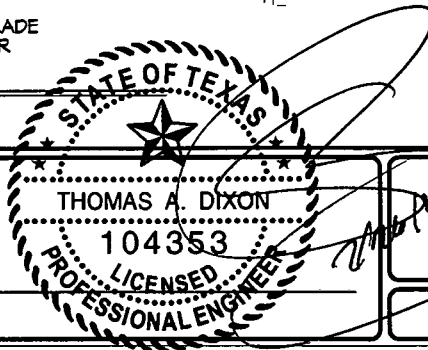

COOK PORTABLE WAREHOUSES
MASTER ANCHORING PLAN
100 DOUGLAS STREET
VALDOSTA, GA 31601
PHONE: 1-229-241-8805

ANCHORING DETAILS

REV	BY	DATE

DATE: 3/13/12
DRN BY: JDA
CHK BY: TAD
SCALE: AS NOTED
I/O. NO: 445-063

SHEET

A-7

8 of 10

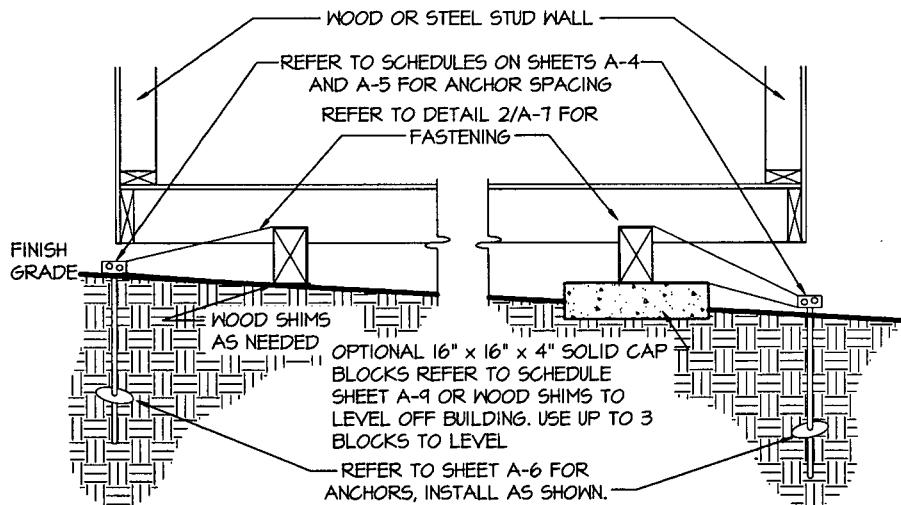

1
A-B
SCALE: N.T.S.

SKIDS ON GRADE & CONC. PADS
VERTICAL ANCHOR UN-LEVEL GROUND
SECTION

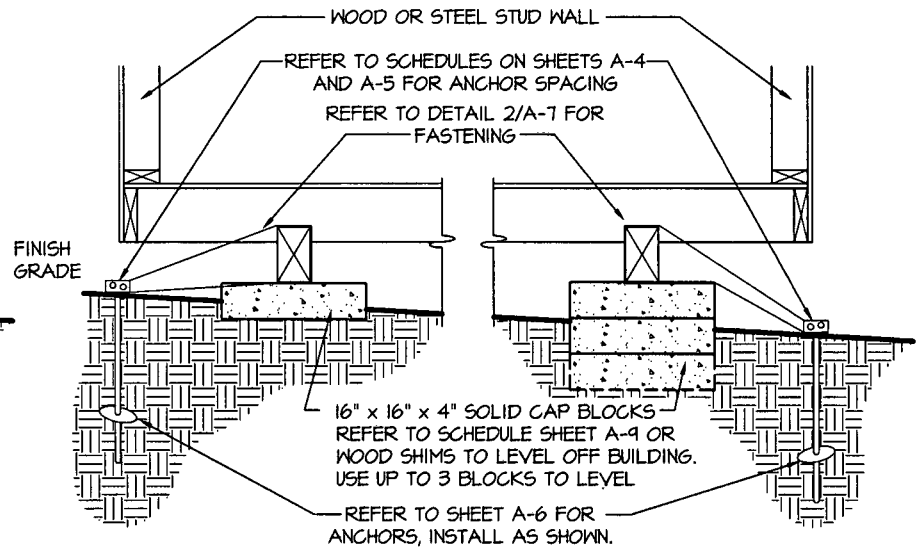

2
A-B
SCALE: N.T.S.

ALL SKIDS ON CONC. PADS
VERTICAL ANCHOR UN-LEVEL GROUND
SECTION

THOMAS A. DIXON, P.E.

AL# 30637	TX# 104353	DIXON ENGINEERING, INC.
SC# 27542	VA# 045543	STRUCTURAL ENGINEERING AND
WV# 071936	FL# 34222	INSPECTION - COA 8145
PA# 079009	KS# 21148	10410 MAIN STREET
TN# 112761	GA# 034371	THONOTOSASSA, FL 33542
MS# 14034	MD# 40905	VOICE: 813-482-4885
NC# 035485		FAX: 813-482-2306

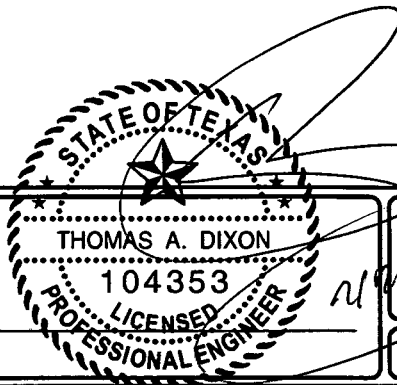

COOK PORTABLE WAREHOUSES
MASTER ANCHORING PLAN
100 DOUGLAS STREET
VALDOSTA, GA 31601
PHONE: 1-229-241-8805

ANCHORING DETAILS

REV	BY	DATE

DATE:	3/13/12
DRN BY:	JDA
CHK BY:	TAD
SCALE:	AS NOTED
W.O. NO.:	445-063

SHEET

A-8

9 of 10